

SBS15-20N Series

Sit-on Stacker • AC Power • 1.5 – 2.0 ton

SBS15N
SBS15NI
SBS20N

Performance, durability and comfort combine... for non-stop productivity

The 'do-it-all' SBS15-20N series not only stacks heavy loads at heights up to 6.5 metres but works in narrower aisles than a reach truck and transports goods efficiently over long distances. Powerful, fast and controllable, the SBSN combines excellent performance with effortless, precise steering, ergonomic controls and a comfortable operator compartment... for constant productivity through the longest of shifts.

All three models in the series have high residual capacities, while the initial lift model also offers increased ground clearance for use on ramps. A low-maintenance AC drive motor, long service interval and rapid access to all components reduces costs and

maximises uptime. Meanwhile, the robust structure of the chassis and mast protects both operator and truck from accidental damage. The 2.0 ton model is fitted with the revolutionary Visionmast, which gives even better views to the fork tips.

Frame and body

- **Robust chassis** offers exceptional durability and driver protection.
- **High-visibility design** maximises view of fork tips and working area, especially on 2.0 ton model.

Mast and fork assembly

- **High stability, lifting power and mast strength** mean excellent residual capacities.
- **Extendable side stabilisers** offer extra residual capacity (standard on triplex masts, optional on duplex).
- **Rounded fork tips** ensure smooth pallet entry/exit and make it easier to enter the pallet at an angle.



 **MITSUBISHI**
FORKLIFT TRUCKS

SBS15-20N Series

Sit-on Stacker

AC Power • 1.5 – 2.0 ton

Characteristics				
1.01	Manufacturer (abbreviation)		Mitsubishi	Mitsubishi
1.02	Manufacturer's model designation		SBS15N	SBS15NI
1.03	Power source: (battery, diesel, LP gas, petrol)		Battery	Battery
1.04	Operator type: pedestrian, (operator)-standing, -seated		Sit-on	Sit-on
1.05	Load capacity	Q (kg)	1500	1500
1.06	At load centre	c (mm)	600	600
1.08	Load wheel axle to fork face (forks lowered)	x (mm)	775	755
1.09	Wheelbase	y (mm)	1500	1520
Weight				
2.01	Truck weight with nominal load & battery	kg	3260*	3340*
Wheels, Drive Train				
3.01	Tyres: P=Polyurethan, PT=Power Thane, Vul=Vulkollan, drive/load side		Vul/Vul	Vul/Vul
3.02	Tyre dimensions, front		250 x 100	250 x 100
3.03	Tyre dimensions, rear		85 x 75	85 x 75
3.04	Castor wheel dimensions (diameter x width)		150 x 48	150 x 48
3.05	Number of wheels, front/rear (x=driven)		1x + 2 / 4	1x + 2 / 4
3.06	Track width (centre of tyres), load side	b10 (mm)	385	385
3.07	Track width (centre of tyres), drive side	b11 (mm)	690	690
Dimensions				
4.02	Height with mast lowered (see tables)	h1 (mm)	2385	2500
4.03	Free lift (see tables)	h2 (mm)	1810	1810
4.04	Lift height (see tables)	h3 (mm)	5400	5400
4.05	Overall height with mast raised	h4 (mm)	5940	6055
4.06	Initial lift	h5 (mm)	-	115
4.07	Height to top of overhead guard	h6 (mm)	1930	1930
4.08	Seat height or platform height	h7 (mm)	400	400
4.15	Fork height, fully lowered	h13 (mm)	90	92
4.19	Overall length	l1 (mm)	2110	2145
4.20	Length to fork face (includes fork thickness)	l2 (mm)	960	960
4.21	Overall width	b1/b2 (mm)	1050 / 1550**	1050 / 1550**
4.22	Fork dimensions (thickness, width, length)	s / e / l (mm)	65 / 185 / 1150	65 / 185 / 1150
4.25	Outside width over forks (minimum/maximum)	b5 (mm)	550-685	570-685
4.32	Ground clearance at centre of wheelbase, with load (forks lowered)	m2 (mm)	30	30
4.33/a	Working aisle width (Ast) with 1000 x 1200 mm pallets, load crosswise	Ast (mm)	2626	2633
4.33/b	Working aisle width (Ast3) with 1000 x 1200 mm pallets, load crosswise	Ast3 (mm)	2210	2230
4.34/a	Working aisle width (Ast) with 800 x 1200 mm pallets, load lengthwise	Ast (mm)	2569	2583
4.34/b	Working aisle width (Ast3) with 800 x 1200 mm pallets, load lengthwise	Ast3 (mm)	2410	2430
4.35	Turning circle radius	Wa (mm)	1785	1785
Performance				
5.01	Travel speed, with/without load	(km/h)	7.0 / 8.0	7.0 / 8.0
5.02	Lifting speed, with/without load	(m/s)	0.13 - 0.30	0.13 - 0.30
5.03	Lowering speed, with/without load	(m/s)	0.50 - 0.35	0.50 - 0.35
5.07	Gradeability, with/without load	%	7 / 10	7 / 10
5.10	Service brakes (mechanical/hydraulic/electric/pneumatic)		Electric	Electric
Electric motors				
6.01	Drive motor capacity (60 min. short duty)	(kW)	2.2	2.2
6.02	Lift motor output at 15% duty factor	(kW)	5.5	5.5
6.04	Battery voltage/capacity at 5-hour discharge	(V/Ah)	24 / 375 - 500	24 / 375 - 500
6.05	Battery weight	(kg)	305 - 400	305 - 400
Miscellaneous				
8.01	Type of drive control		Stepless	Stepless
8.04	Noise level, mean value at operator's ear	dB(A)	66	66

Continuing improvement may lead to changes in these specifications.

* 1500 kg models with TREV5400 mm mast, 2000 kg model with 6300 mm mast

** without / with stabilisers extended



Rounded fork tips



Powerful AC motor



Comprehensive LCD display

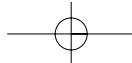

	Mitsubishi
	SBS20N
	Battery
	Sit-on
	2000
	600
	805
	1585
	4100*
	Vul/Vul
	250 x 100
	85 x 90
	150 x 48
	1x + 2 / 4
	375
	690
	2710
	2060
	6300
	7130
	-
	1930
	400
	90
	2160
	1010
	1050 / 1715**
	65 / 195 / 1150
	570-685
	25
	2696
	2260
	2627
	2460
	1865
	7.0 / 8.0
	0.11 / 0.30
	0.50 - 0.40
	6 / 10
	Electric
	2.2
	5.5
	24 / 375 - 500
	305 - 400
	Stepless
	66

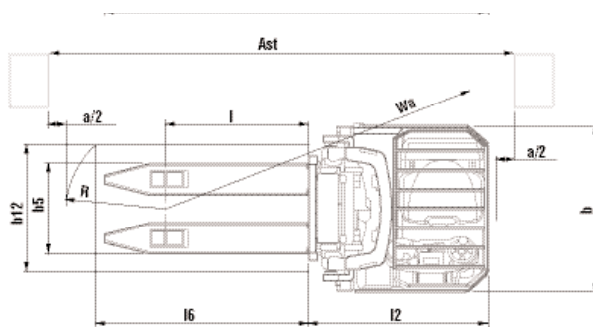
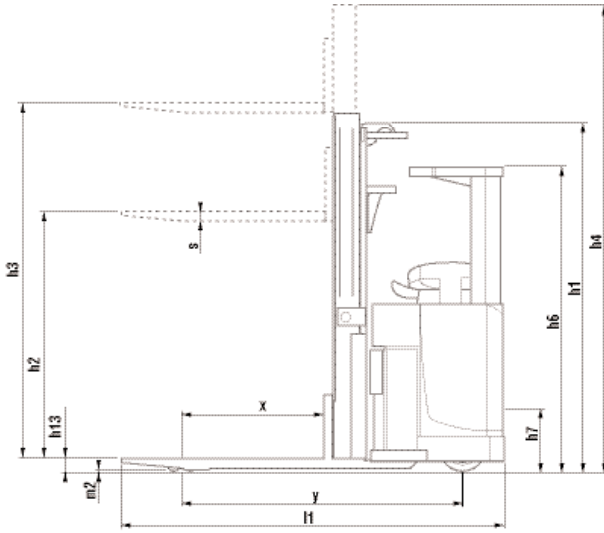

- Ast = Working aisle width
- Ast3 = Working aisle width (b12 ≤ 1000 mm)
- $Ast = Wa + \sqrt{(l6 - x)^2 + (b12 / 2)^2} + a$
- Ast3 = Wa + l6 + a
- Wa = Turning radius
- l6 = Pallet length
- x = Load wheel axle to fork face
- b12 = Pallet width
- a = Safety clearance = 2 x 100 mm

- h1 Height with mast lowered
- h2 Standard free lift
- h3 Lift height
- h4 Height with mast raised
- h5 Full free lift
- Q Lifting capacity, rated load
- c Load centre (distance)

SBS15N				
Mast type	h3 mm	h1 mm	h4 mm	h2 mm
Simplex	1500	1950	1950	1500
Duplex	2500	1835	3000	1365
	2900	2035	3400	1565
	3300	2235	3800	1765
	3450	2310	3950	1840
	3600	2385	4100	1915
Duplex Free-lift	4300	2735	4800	2265
	2500	1835	3000	1365
	2900	2035	3400	1565
	3300	2235	3800	1765
	3450	2310	3950	1840
Triplex	3600	2385	4100	1915
	4300	2735	4800	2265
	5400	2385	5940	1900
Triplex Free-lift	5900	2555	6440	2070
	6500	2755	7040	2270
	5400	2385	5940	1900
Triplex Free-lift	5900	2555	6440	2070
	6500	2755	7040	2270

SBS15NI				
Mast type	h3 mm	h1 mm	h4 mm	h2 mm
Simplex	1500	2065	2065	1500
Duplex	2500	1950	3115	200
	2900	2150	3515	200
	3300	2350	3915	200
	3450	2425	4065	200
	3600	2500	4215	200
Duplex Free-lift	4300	2850	4915	200
	2500	1950	3115	1365
	2900	2150	3515	1565
	3300	2350	3915	1765
	3450	2425	4065	1840
Triplex	3600	2500	4215	1915
	4300	2850	4915	2265
	5400	2500	6055	-
Triplex Free-lift	5900	2670	6555	-
	6500	2870	7155	-
Triplex Free-lift	5400	2500	6055	1900
	5900	2670	6555	2070
	6500	2870	7155	2270

SBS20N				
Mast type	h3 mm	h1 mm	h4 mm	h2 mm
Triplex Visionmast	4800	2210	5630	1650
	5400	2410	6230	1850
	5700	2510	6530	1950
	6300	2710	7130	2150

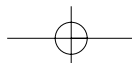



Side stabilisers (see options)



'Fly-by-wire' steering

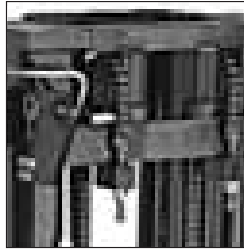

Robust mast

Drive

- **Powerful AC motor** means high drive speed and acceleration – even when loaded – plus smooth, quiet, controlled operation, extended shift length and lower maintenance requirements.

Steering system

- **360-degree electronic 'fly-by-wire' steering** offers precise turning with minimal effort, even at high speeds.
- **Progressive steering** allows easy manoeuvring at low speeds and steady control when moving fast.

Brakes

- **Regenerative braking** gives effective control, reduced brake wear and longer shift life.

Hydraulics

- **Smooth hydraulics** ensure jolt-free fork movement for careful handling of loads.

Electrical and control systems

- **Large battery compartment** accommodates high-capacity batteries (up to 500 Ah).
- **PIN code start-up** with driver-specific settings is included as standard to prevent unauthorised or inappropriate use
- **Programmable controller** adjusts acceleration, travel speed, lift speed and braking to suit the application and operator – for great versatility.

- **Battery roller system** is fitted as standard for rapid exchanges.
- **Battery discharge indicator and lift cut-out** are provided for battery protection.
- **Automatic, stepless speed reduction system** constantly monitors lift height and steering angle and adjusts speed to ensure safe, controlled performance.

Operator environment and controls

- **Ergonomic operator compartment** with adjustable armrest and carefully positioned controls reduces driver fatigue and increases precision.
- **Full-suspension, fully adjustable seat** with optional hip restraints and belt keeps driver safe and comfortable through the longest of shifts.
- **Load weight indicator** is specified as standard to avoid exceeding safe capacity.

- **Clear LCD display** keeps operator and service engineer fully informed – helping to avoid damage and encourage maintenance.
- **User-friendly operator menu** gives easy-to-follow instructions and allows operator to tune truck to own preference.

Other features

- **Swing-open seat** allows quick and easy entry to all areas for checks and maintenance.
- **Long service interval** reduces cost of ownership and increases uptime.

Options

- **Wide variety of fork dimensions**
- **Customer name/logo/artwork** on side panels
- **Pallet entry and exit rollers**
- **Side stabilisers** (standard on triplex masts, optional on duplex)
- **Compulsory activation of side stabilisers** at 2.5 m lift or higher
- **Choice of wheel materials**
- **List bracket or PC support**
- **Key switch** instead of start/stop button

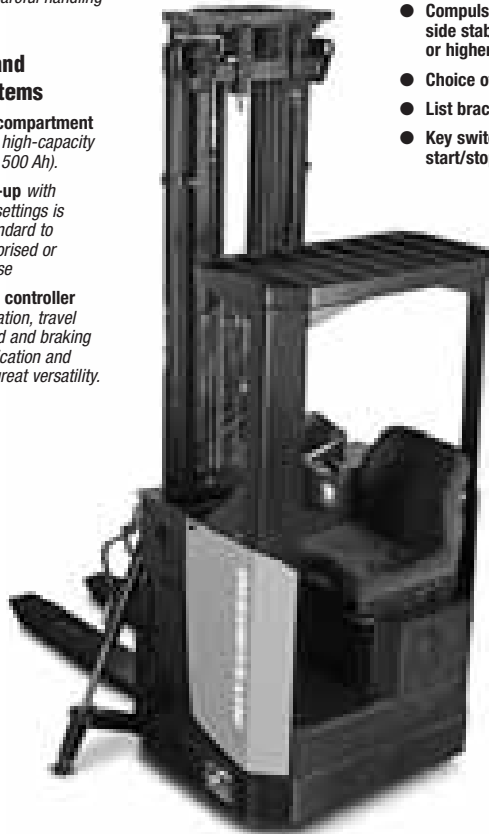

ready to
perform
to your **applications**

Developed for outstanding performance and genuine value for money, the award-winning* range of Mitsubishi forklift trucks and warehouse equipment is built to a higher specification to maximise productivity and ensure utter reliability... whatever the application.

It's what you'd expect from one of the world's largest corporations whose companies are at the leading edge of technologies where performance, quality and dependability can never be compromised.

It means that, from a single safe source, we can meet 98% of all handling requirements, supplied to you via a range of competitive finance options including outright purchase, rental or leasing. So your local dealer can advise you on precisely the right product for your application... and your budget.

Moreover, because we understand how much you depend on your Mitsubishi forklift truck, we deliver the highest levels of customer support.

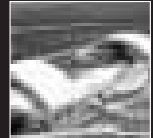

* Mitsubishi Forklift Trucks has won **four** separate Fork Lift Truck Association Annual Awards for Excellence covering the areas of **Ergonomics, the Environment and Innovation.**



enquiry@mitforklift.com.sg

www.mitforklift.com.sg

Copyright © 2008 by MCFS, All Rights Reserved. All registered trademarks are the property of their respective owners. Printed in Singapore.

SMT 0087

04/08

Note: Performance specifications may vary depending on standard manufacturing tolerances, vehicle condition, types of tyres, floor or surface conditions, applications or operating environment. Trucks may be shown with non-standard options. Specific performance requirements and locally available configurations should be discussed with your Mitsubishi forklift truck dealer. Mitsubishi Forklift Trucks follows a policy of continual product improvement. For this reason, some materials, options and specifications could change without notice.